

Records Management and Interoperability – Initiatives and Experiences in the EU and Estonia

September 18, 2012

Liivi Karpištšenko – Ministry of Economic Affairs
and Communication

Kuldar Aas – National Archives

Estonia



- Management and cross-border exchange of records* – challenges
- What is being done in Europe?
- What has been done in Estonia? (Document Exchange Centre DEC, in operation since 2006)
- What will be done in Estonia? (DEC, next steps)

*record = unalterable document + metadata

Records Management and Exchange – Challenges

Same basic principles. Need for interoperability:

- Different rules and regulations
- Terminology issues
- Different software (EDRMSs + other systems)

Currently: IT solutions designed at national levels. Internationally – records exchanged on paper (slow, ineffective to integrate in records management workflows) or via e-mail (unsafe, unreliable)

Cross-border Records Exchange: Challenges

- To achieve seamless cross-border records exchange we need actions on different levels of interoperability:
 - **Organisational and legal:** need to align legislation to mandate the use of necessary tools and principles (i.e. acceptance of digital signatures)
 - **Semantic:** establishment on the mandatory metadata to be exchanged together with records
 - alternatively: creation of practical metadata crosswalks based on national standards)
 - **Technical:** develop and apply necessary infrastructure and technical guidelines

Relevant international solutions

- DLM Forum / MoReq
 - **MoReq**: Modular Requirements for Records Systems
 - <http://www.dlmforum.eu/>
 - <http://www.moreq2010.eu/>
 - Provides a framework to manage records in a common manner
 - Includes a model metadata service description which might also be used for records exchange purposes

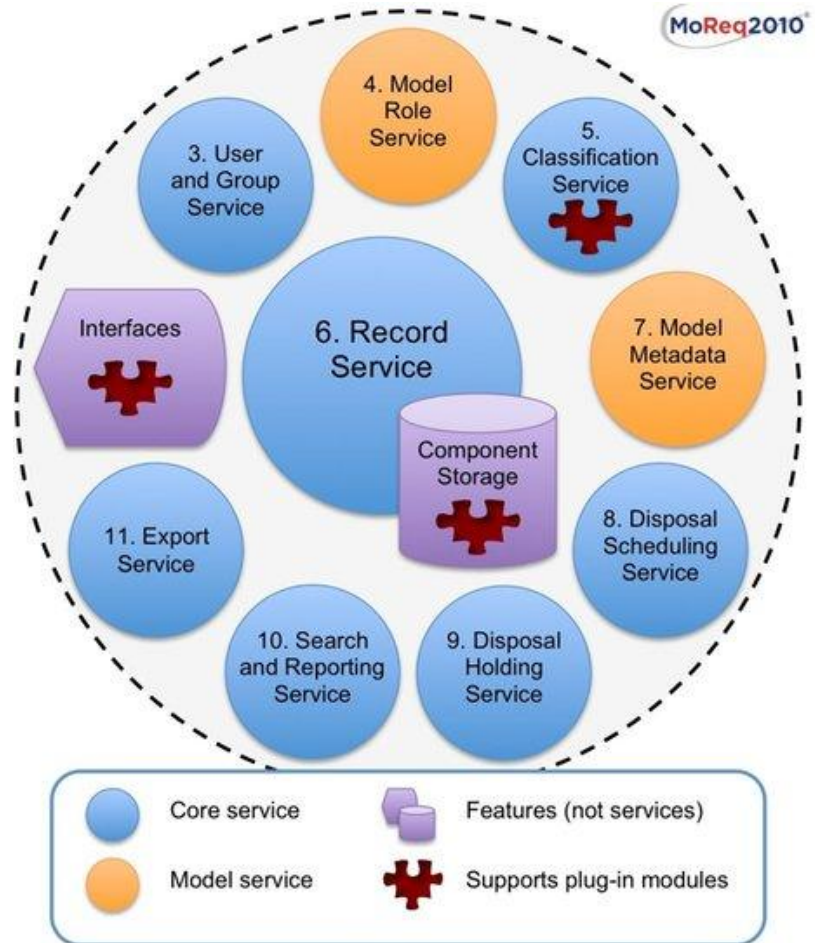

Relevant international solutions

- CMIS: Content Management Interoperability Services
 - <http://xml.coverpages.org/cmis.html>
- Industry initiative to provide practical web services for content discovery and exchange between different systems
- Supported by a wide range of software providers
- Allows to build common applications on top of proprietary systems
- Proposed for OASIS standardisation

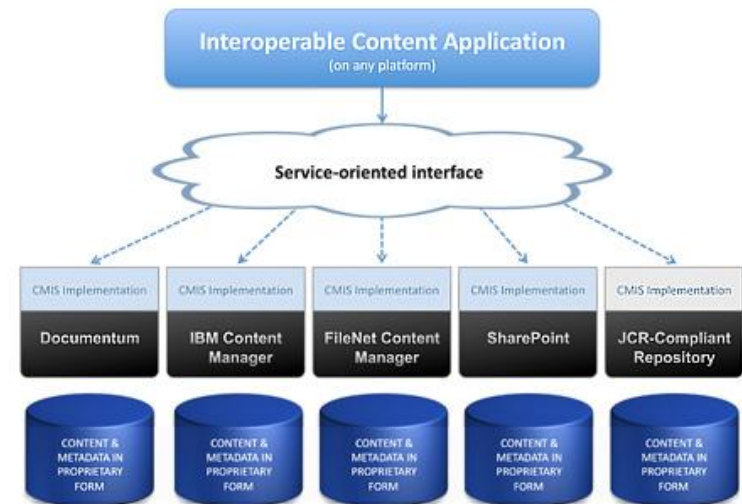

© Copyright 2008 by EMC, IBM and Microsoft. All rights reserved.

Relevant international solutions

- ISA: Interoperability Solutions for European Public Administrations
 - <http://ec.europa.eu/isa/>
- [ISA is] „... facilitating efficient and effective cross-border electronic collaboration between European public administrations“
- Relevant actions:
 - Interoperability architecture
 - Sub-action: Towards the full digitisation of EU document exchange
 - Trusted information exchange
 - Improving semantic interoperability in European eGovernment systems
 - STORK related sub-actions
 - PEPPOL, e-PRIOR, e-Trustex, ...

What has been done in Estonia?

- “Chapter 0” to MoReq2 –
<http://www.dlmforum.eu/> – > MoReq2010 –>
MoReq2 –> MoReq2 Translations
- Minimum requirements for EDRMSs
- Records Management Metadata Set
- XML repository, incl. record type descriptions
- **Document Exchange Centre (DEC)**

X-Road and DEC

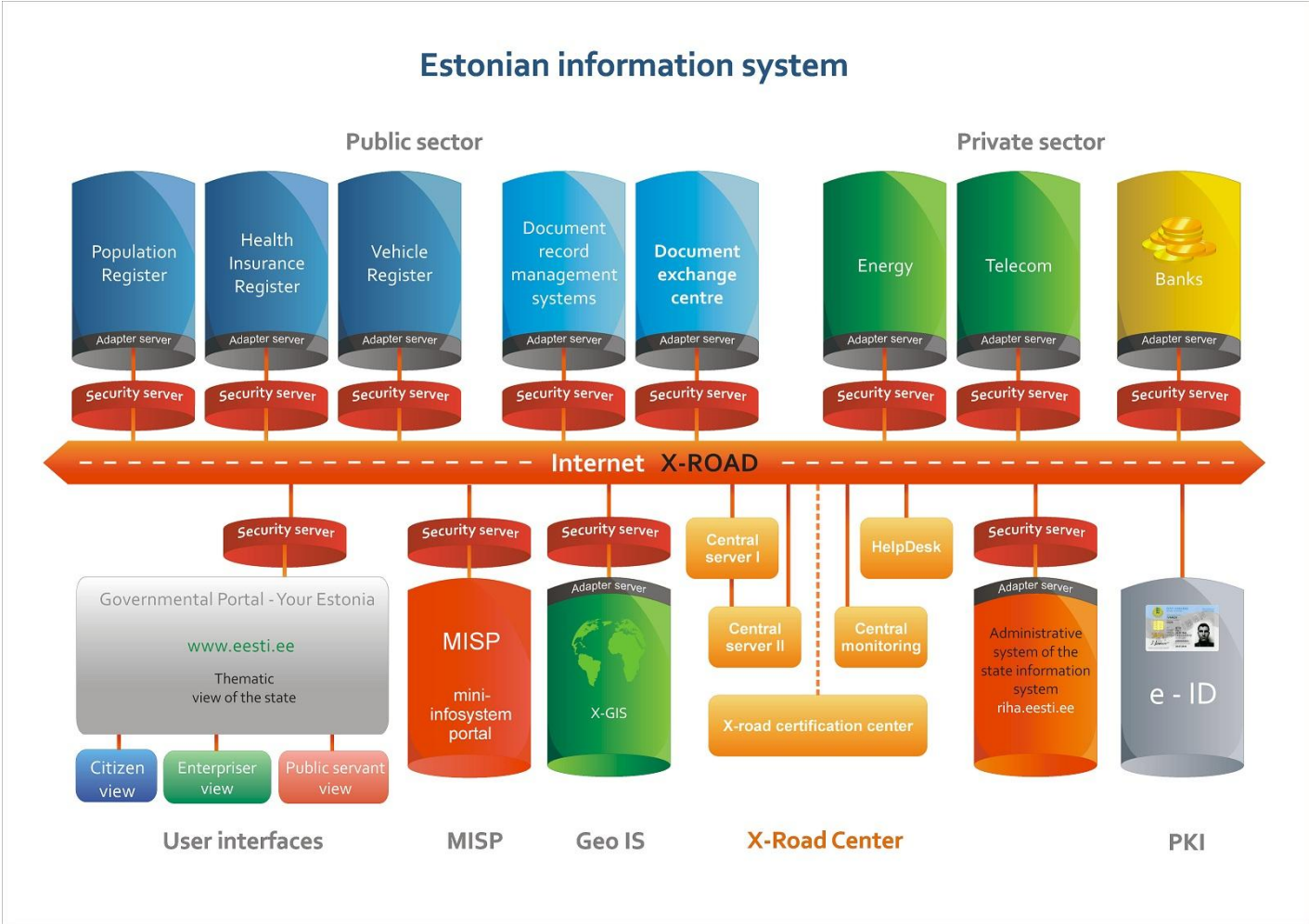

X-Road and DEC

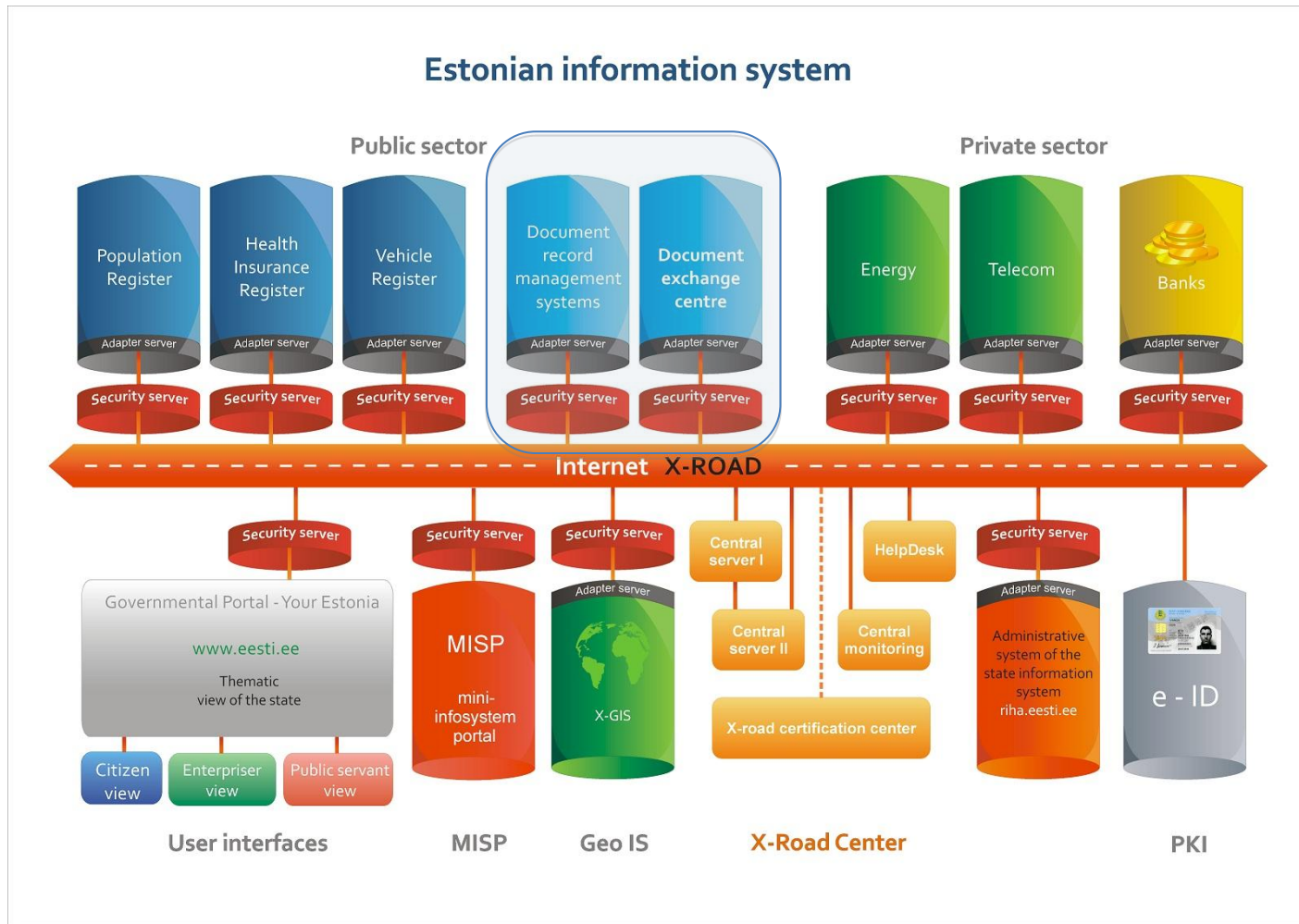

Document Exchange Centre – DEC

- information system providing a common central records exchange service for various document and records managements systems (EDRMS) and other information systems dealing with documents/records

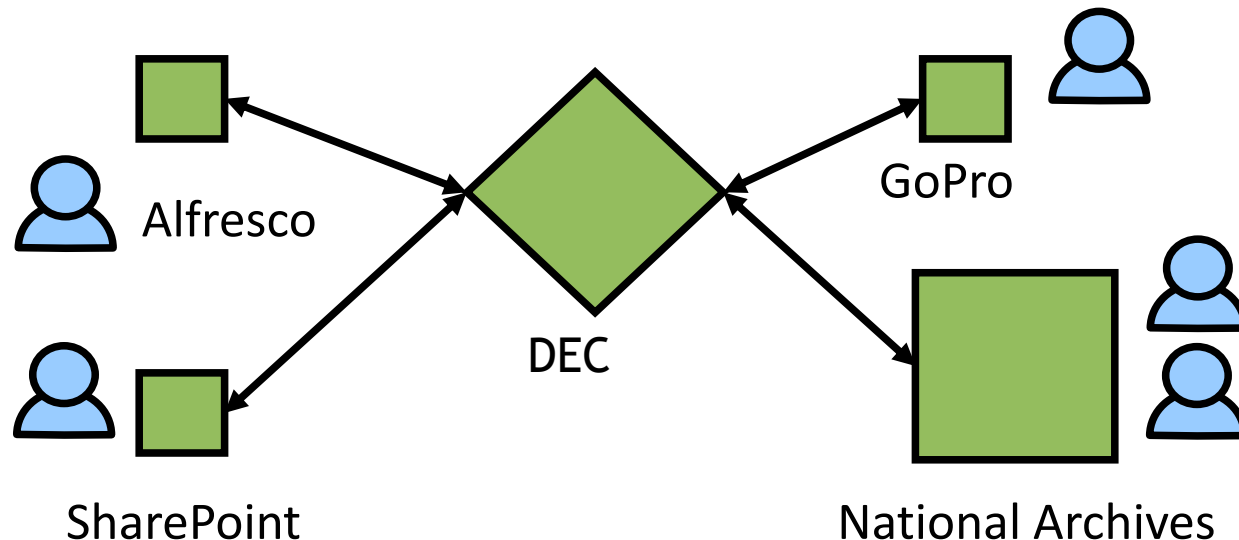

Document Exchange Centre – DEC

- In operation since 2006
- European e-Government awards:
- Merits (compared to e-mail):
 - secure transfer
 - no spam
 - tested with large files (several GBs)
 - agreed set(s) of metadata
 - asynchronous process; feedback (received)



DEC Users, September 2012



Public sector

- **Constitutional institutions – 84%**
- **Government Office + ministries – 100%**
- **County governments – 100%**
- **Governmental agencies – 100%**
- **Local governments – 78%**
- **Others (public sector) ~ 20%**

DEC – Cost Savings

100 records via DEC – cost and resource savings

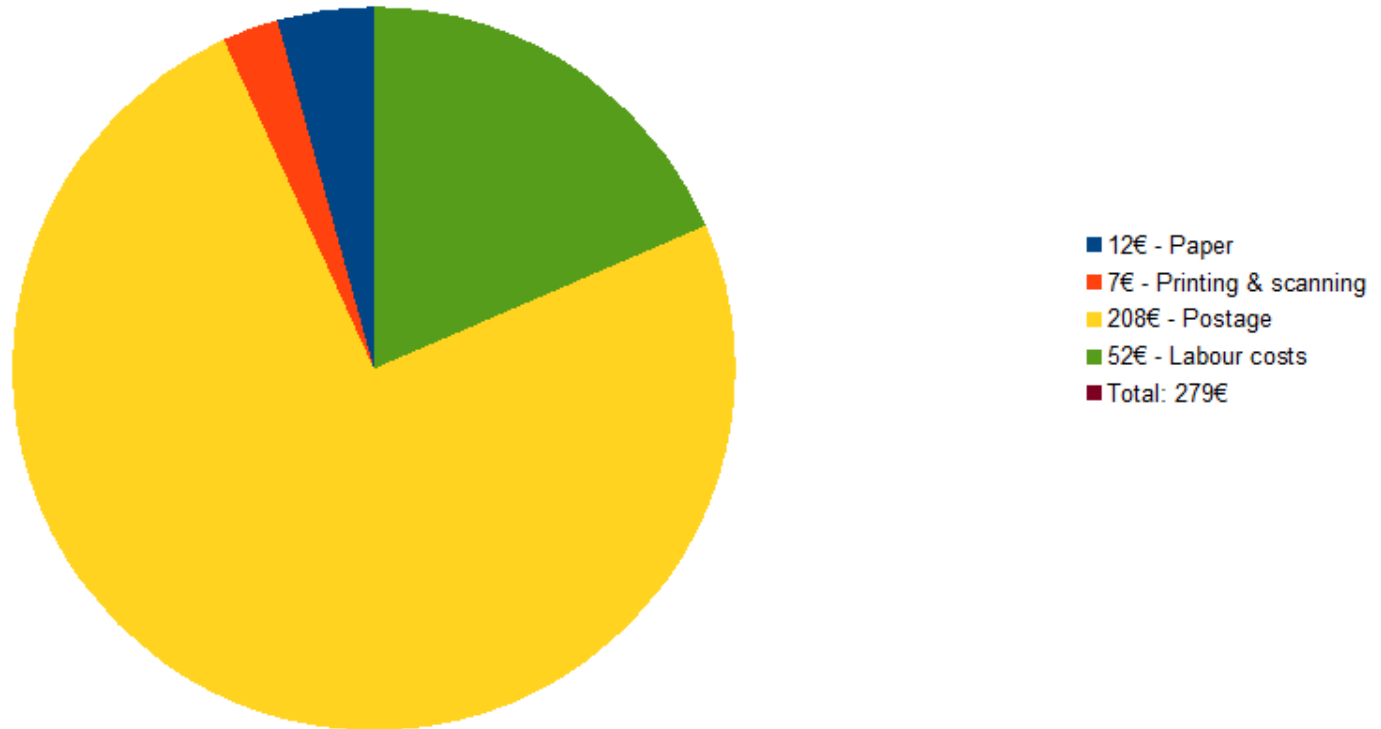

*Based on calculations by ministries & state agencies

DEC – Cost Savings

DEC - Cost and Resource Savings

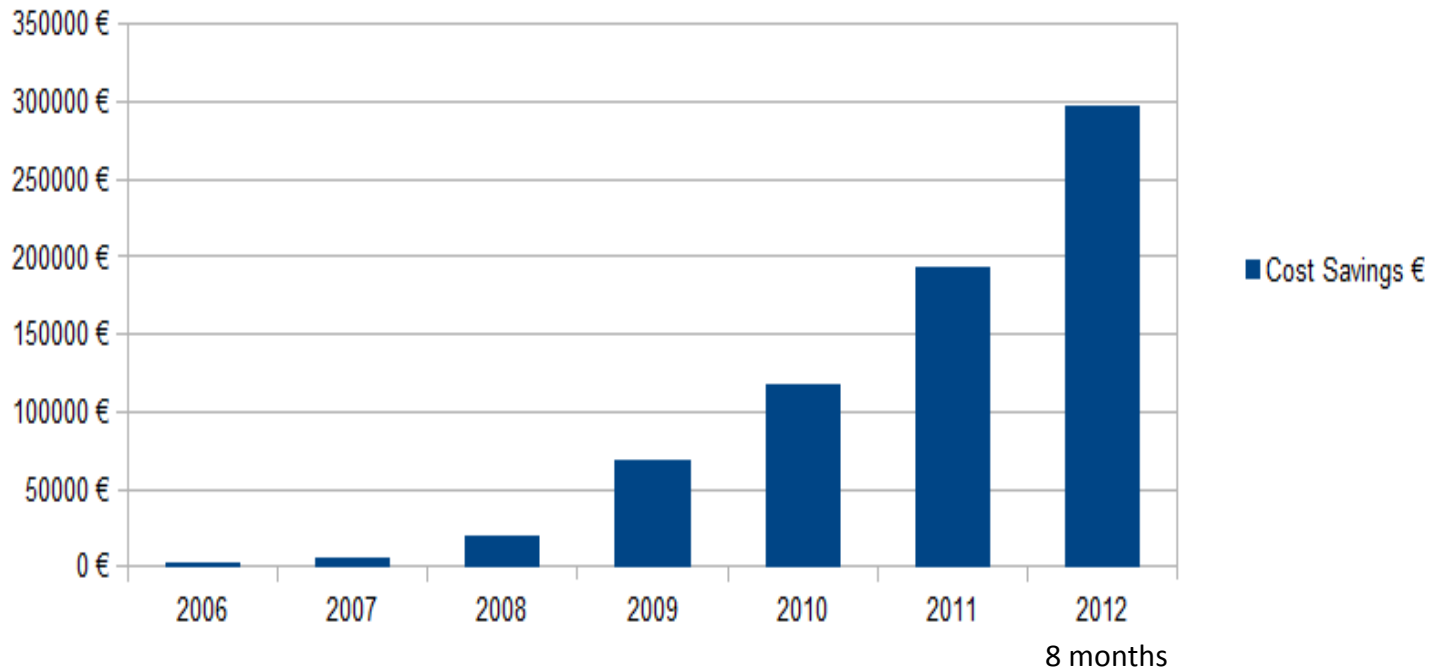

* Calculations based on the number of records exchanged via DEC

DEC – IT Costs vs Cost Savings

eRecords Exchanged via DEC

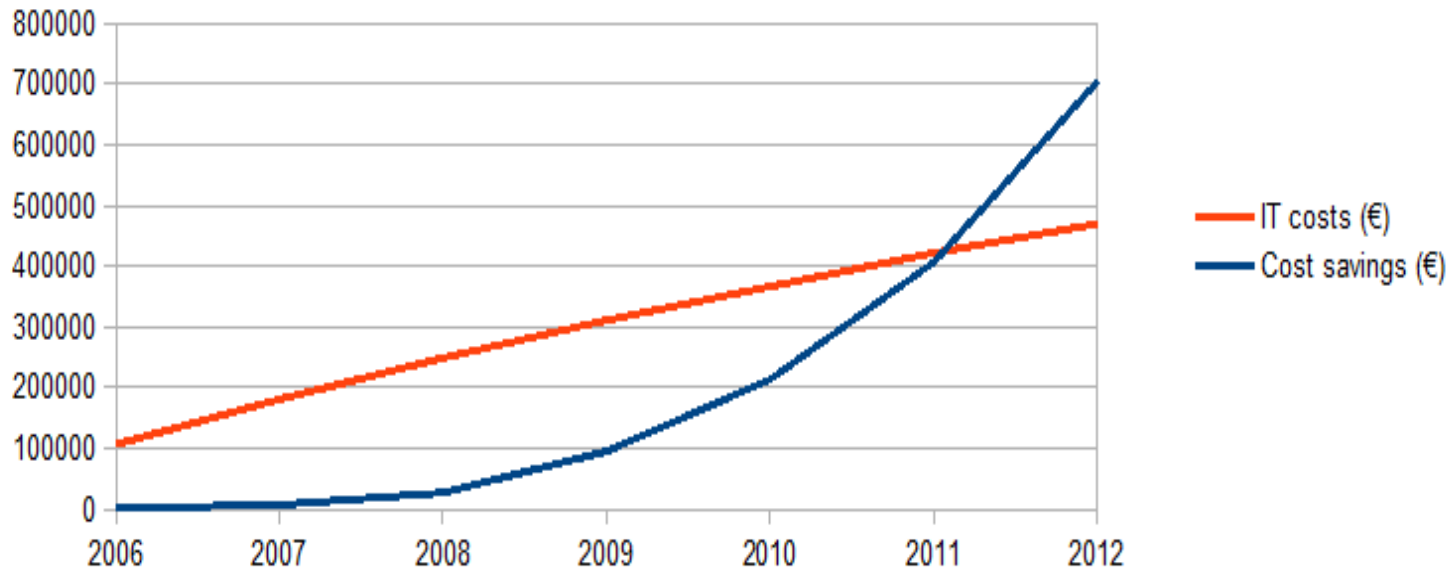

* IT costs (cumulatively): DEC interfaces, system development, server costs, labour costs, etc. Based on estimations by Estonian Information System's Authority.

Paperless records exchange?

- April 2012, % of overall correspondence *:
paper records received: 28%, sent: 34%
- Main reasons – correspondence received from / sent to:
 - citizens
 - entrepreneurs
 - **foreign partners**

* Based on statistics by 9 ministries, Government Office, and National Archives

DEC – next steps

- Further encouragement of state and local government agencies to join DEC
- For citizens and entrepreneurs – service “My Documents” (State Portal eesti.ee)
- **For foreign partners** – X-Road Europe, DEC Europe (+ local operators)

X-Road Europe, DEC Europe

- Existing new X-Road Europe environments for cross-border data exchange:
 - Development
 - Testing
 - Live
- (2012-2013) DEC “clone” on X-Road Europe – all Estonian clients of DEC can exchange records with clients of DEC Europe in other countries (also via local operators)
- Existing interfaces of DEC for EDRMSs: Alfresco, GoPro, LiveLink/OpenText, SharePoint, DocLogix

DEC Europe

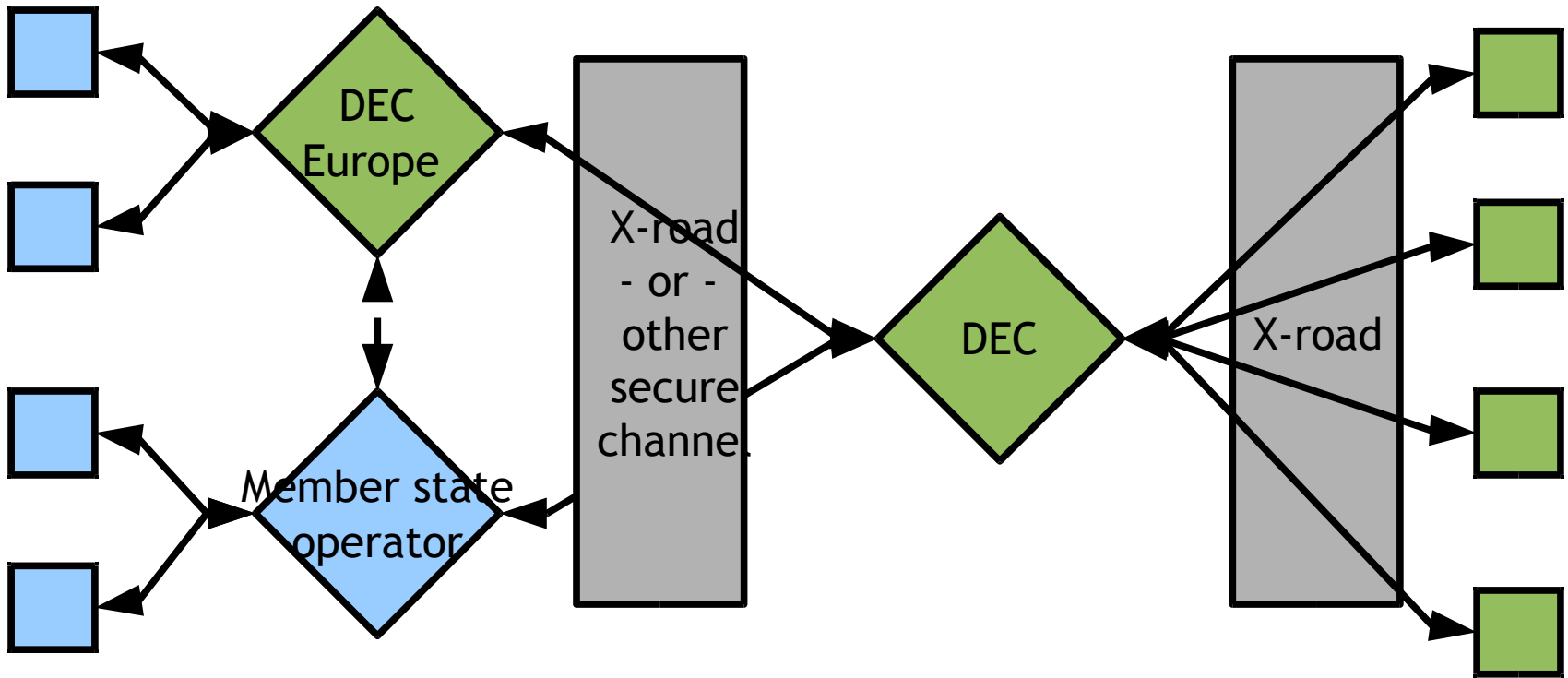

Call for Cooperation

- Cross-border records exchange

Interested parties to

- be involved,
- share information,
- test and pilot,
- have information about the course of the project?

Leave your contacts (to be contacted by the Estonian Information System's Authority)

Thank you

liivi.karpistsenko@mkm.ee
kuldar.aas@ra.ee